

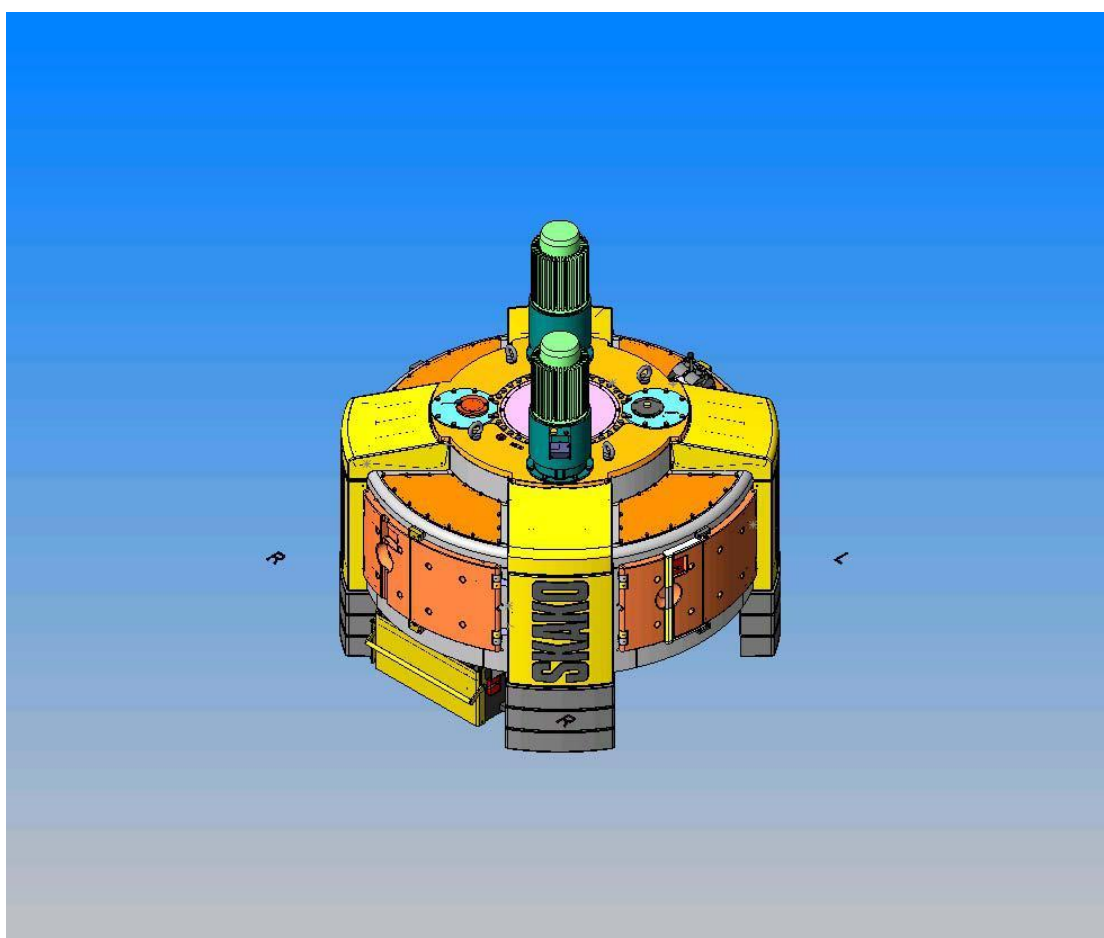

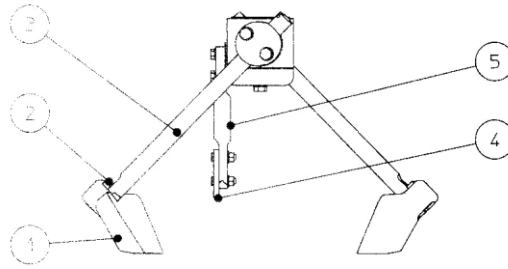



Смеситель/Blander/Mixer AM 1500



Gældende fra / Date of issue	
Gældende til / Valid until	
SKAKO's terms of sale and delivery of spare parts and services	

Blanderværktøj/mixerstar



Pos nr. Pos No.	Vare Item	Tekst Description	Antal Qty.	Vare nr. Item No.	Pris/stk. Price/pcs. (EURO)
1		Gummiskovl Rubber shovel	4	11006387	
2		Kile Wedge	4	11006183	
3		Arm for skovl Arm shovel	4	11006372	
4		Top skovl Top shovel	2	11008555	
		Skrue/screw	4	652278	
		Skive/washer	8	651153	
		Møtrik/nut	4	651136	
5		Arm for top skovl Arm for top shovel	2	11007207	



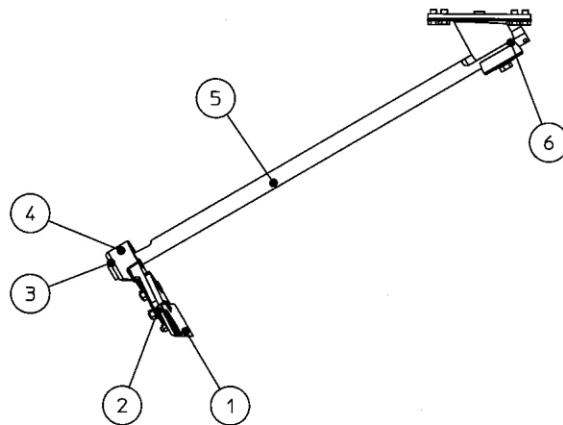

Hjørneskraber/Edge scraper

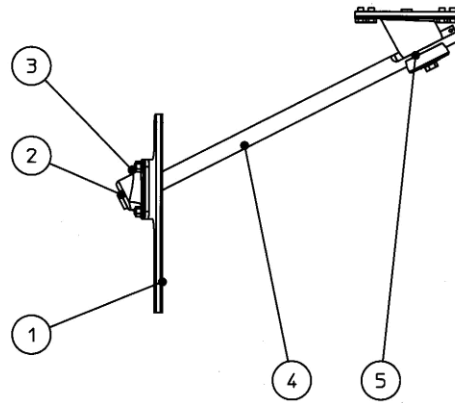

Pos nr. Pos No.	Vare Item	Tekst Description	Antal Qty.	Vare nr. Item No.	Pris/stk. Price/pcs. (EURO)
1		Slidspids Wearing point	1	11007479	
		Møtrik/nut Skive/washer	1 1	651135 651152	
2		Hjørneskraber Edge scraper	1	11006774	
		Skrue/screw Skive/washer Møtrik/nut	2 2 2	652278 651153 651136	
3		Kile Wedge	1	11006183	
4		Beslag for hjørneskr Fitting edge scraper	1	11006186	
5		Arm for hjørneskraber Arm edge scraper	1	11006378	
6		Gummiskive Rubber washer	2	11006538	

Sideskraber/Side scraper



Pos nr. Pos No.	Vare Item	Tekst Description	Antal Qty.	Vare nr. Item No.	Pris/stk. Price/pcs. (EURO)
1		Sideskraber Side scraper Skrue/screw Skive/washer Møtrik/nut	1 2 2 2	11006770 651335 651153 651136	
2		Kile Wedge	1	11006183	
3		Montagebeslag Fitting side scraper	1	11006247	
4		Arm for sideskraber Arm scraper	1	11006477	
5		Gummiskive Rubber washer	2	11006538	



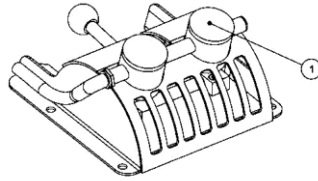

Inspektionsluge/Inspection hatch

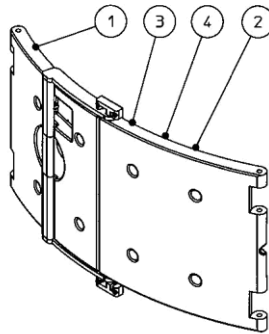

Pos nr. Pos No.	Vare Item	Tekst Description	Antal Qty.	Vare nr. Item No.	Pris/stk. Price/pcs. (EURO)
1		Halogenpære Halogen bulb	2	11008773	







Serviceuge/Service door

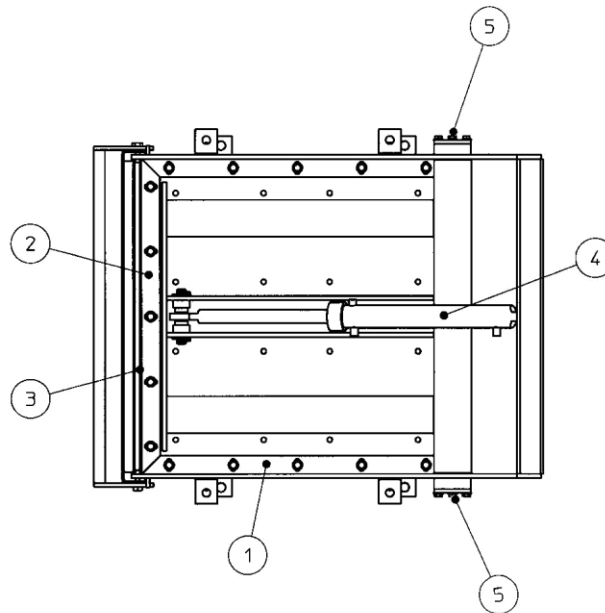



Pos nr. Pos No.	Vare Item	Tekst Description	Antal Qty.	Vare nr. Item No.	Pris/stk. Price/pcs. (EURO)
1		Tætning, servicedør Sealing, servicedoor	2	11010529	
2		Tætning, servicedør Sealing, servicedoor	2	11010528	
3		Lim Glue	1	11015124	
4		Primer Primer	1	11015125	

Udløbsspjæld/Gate



Pos nr. Pos No.	Vare Item	Tekst Description	Antal Qty.	Vare nr. Item No.	Pris/stk. Price/pcs. (EURO)
1		Tætningsliste, side Sealing rail, side	2	11006985	
2		Tætningsliste, front Sealing rail, front	1	11006984	
3		Slidplade, front Wearingpl. front	1	11010242	
4		Pakningsæt, hydr.cyl Seal kit hydr. ram	1	11014097	
4		Føler, induktiv Sensor, proximity	2	11008531	
4		Kabel for føler Cable for sensor	2	764233	
5		Aut. fedtpatron Grease cartridge aut.	2	11006669	

Diverse / general parts

Pos nr. Pos No.	Vare Item	Tekst Description	Antal Qty.	Vare nr. Item No.	Pris/stk. Price/pcs. (EURO)
1		Aut. fedtpatron Grease cartridge aut. Blander med spul/brønd Mixer with cleaning/drum	3 + 1	11006669 11006669	
2		Hydralisk station/ Hydraulic unit Oliefilter Oil filter cartridge	1	11012068	
3		Hydralisk station/ Hydraulic unit Luftfilter Air filter cartridge	1	11012069	

Svøbslidplade/Wearing shell

Vare nr. udfyldes af kunde / Item No. to be filled in by customer

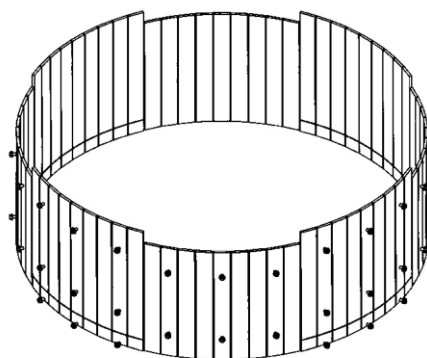

Vare Item	Antal Qty.	Vare nr. Item No.	Pris/stk. Price/pcs. (EURO)
Svøbslidplade Stål Wearing shell Steel	1		
Svøbslidplade Hardox 600 Wearing shell Hardox 600	1		

Bundslidplade/Wearing btm

Vare nr. udfyldes af kunde / Item No. to be filled in by customer

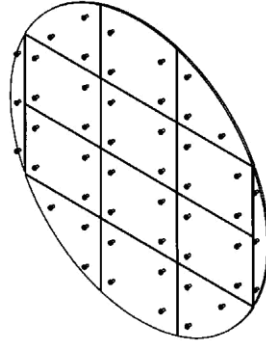

Pos nr. Pos No.	Vare Item	Tekst Description	Antal Qty.	Vare nr. Item No.	Pris/stk. Price/pcs. (EURO)
1		Bundslidplade Wearing btm Hardox 400	1		
1		Bundslidplade Wearing btm Hardox 600	1		
1		Bundslidplade Wearing btm Nihard	1		
2		Aquamatelektrode Aquamate sensor	4	553046	