

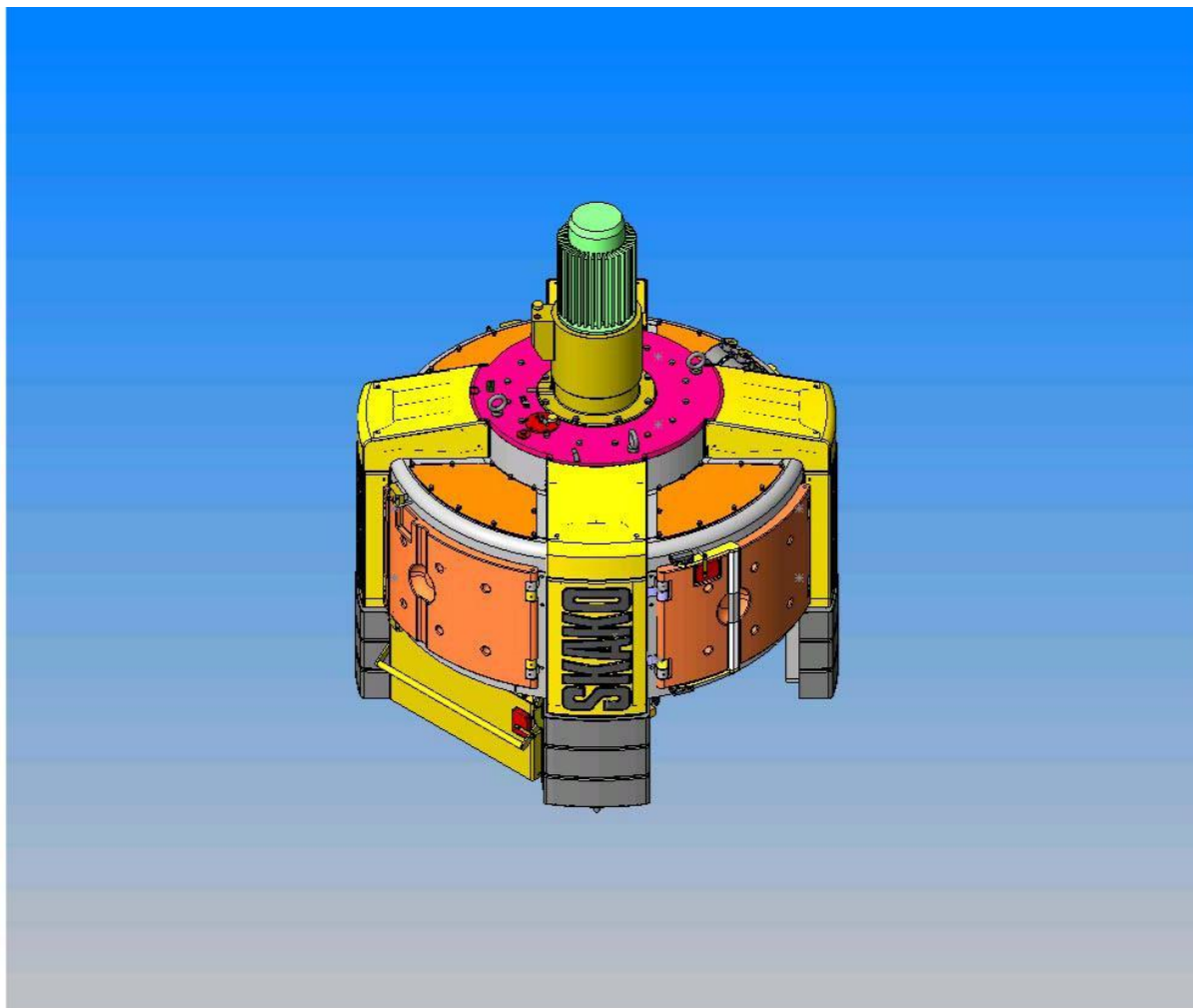

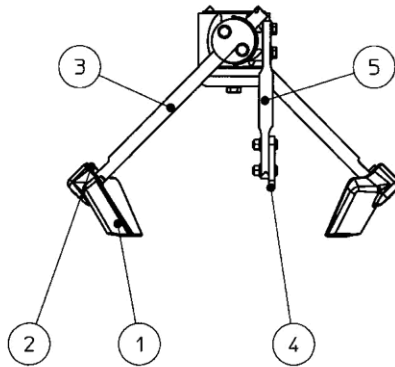



Смеситель/Blander/Mixer AM 750



Gældende fra / Date of issue	
Gældende til / Valid until	

Blanderværktøj/Mixerstar



Pos nr. Pos No.	Vare Item	Tekst Description	Antal Qty.	Vare nr. Item No.	Pris/stk. Price/pcs. (EURO)
1		Gummiskovl Rubber shovel	2	11006802	
2		Kile Wedge	2	11006864	
3		Arm for skovl Arm shovel	2	11006866	
4		Top skovl Top shovel	1	11008555	
		Skrue/screw	2	652278	
		Skive/washer	4	651153	
		Møtrik/nut	2	651136	
5		Arm for top skovl Arm for top shovel	1	11008556	

Hjørneskraber/Edge scraper

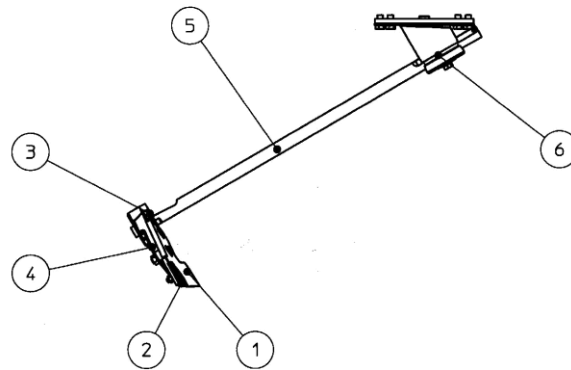

Pos nr. Pos No.	Vare Item	Tekst Description	Antal Qty.	Vare nr. Item No.	Pris/stk. Price/pcs. (EURO)
1		Slidspids Wearing point	1	11007479	
		Møtrik/nut Skive/washer	1 1	651135 651152	
2		Hjørneskraber Edge scraper	1	11008775	
		Skrue/screw Skive/washer Møtrik/nut	2 2 2	652278 651153 651136	
3		Kile Wedge	1	11006864	
4		Beslag for hjørneskr Fitting edge scraper	1	11008631	
5		Arm for side/hjørneskraber Arm edge scraper	1	11008623	
6		Gummiskive Rubber washer	2	11006923	

Sideskraber/Side scraper

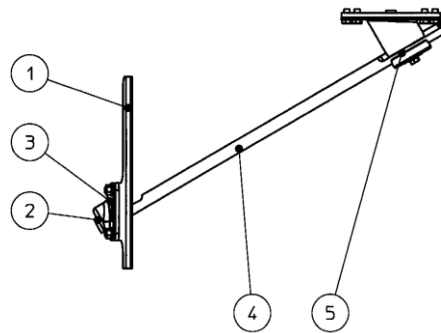

Pos nr. Pos No.	Vare Item	Tekst Description	Antal Qty.	Vare nr. Item No.	Pris/stk. Price/pcs. (EURO)
1		Sideskraber Side scraper	1	11008609	
		Skrue/screw	2	651335	
		Skive/washer	2	651153	
		Møtrik/nut	2	651136	
2		Kile Wedge	1	11006864	
3		Montagebeslag Fitting side scraper	1	11008613	
4		Arm for side/hjørneskraber Arm side/corner scraper	1	11008623	
5		Gummiskive Rubber washer	2	11006923	

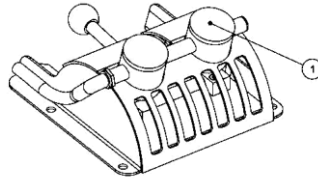

Inspektionsluge/Inspection hatch



Pos nr. Pos No.	Vare Item	Tekst Description	Antal Qty.	Vare nr. Item No.	Pris/stk. Price/pcs. (EURO)
1		Halogenpære Halogen bulb	2	11008773	

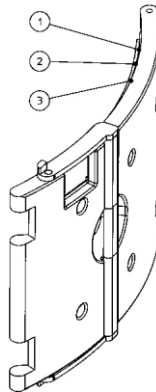





Servicekluge/Service door

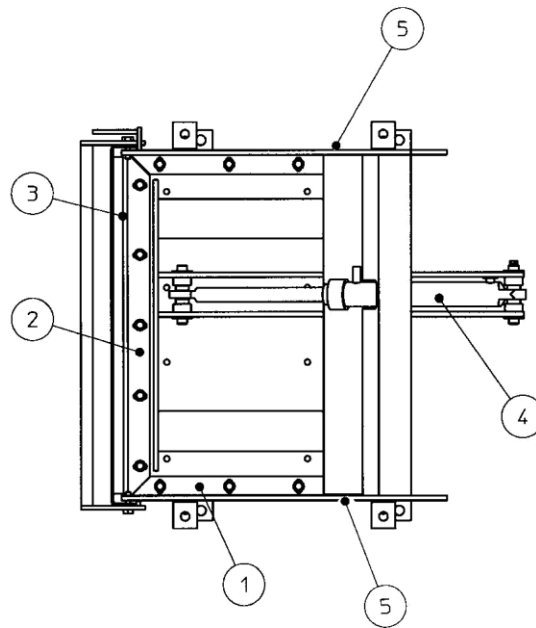



Pos nr. Pos No.	Vare Item	Tekst Description	Antal Qty.	Vare nr. Item No.	Pris/stk. Price/pcs. (EURO)
1		Tætning, servicedør Sealing, servicedoor	2	11010407	
2		Lim Glue	1	11015124	
3		Primer Primer	1	11015125	

Udløbsspjæld/Gate



Pos nr. Pos No.	Vare Item	Tekst Description	Antal Qty.	Vare nr. Item No.	Pris/stk. Price/pcs. (EURO)
1		Tætningsliste, side Sealing rail, side	2	11008182	
2		Tætningsliste, front Sealing rail, front	1	11006984	
3		Slidplade, front Wearingpl. front	1	11010344	
4		Pakningsæt, hydr.cyl Seal kit hydr. ram	1	11014097	
4		Føler, induktiv Sensor, proximity	2	11008531	
4		Kabel for føler Cable for sensor	2	764233	
5		Aut. fedtpatron Grease cartridge aut.	2	11006669	

Diverse / general parts

Pos nr. Pos No.	Vare Item	Tekst Description	Antal Qty.	Vare nr. Item No.	Pris/stk. Price/pcs. (EURO)
1		Aut. fedtpatron Grease cartridge aut.	2	11006669	
2		Hydralisk station/ Hydraulic unit Oliefilter Oil filter cartridge	1	11012068	
3		Hydralisk station/ Hydraulic unit Luftfilter Air filter cartridge	1	11012069	

Svøbslidplade/Wearing shell

Vare nr. udfyldes af kunde / Item No. to be filled in by customer

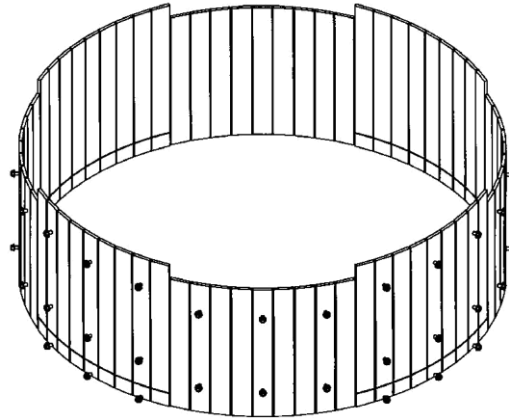

Vare Item	Antal Qty.	Vare nr. Item No.	Pris/stk. Price/pcs. (EURO)
Svøbslidplade stål Wearing shell steel	1		
Svøbslidplade Hardox 600 Wearing shell Hardox 600	1		

Bundslidplade/Wearing btm

Vare nr. udfyldes af kunde / Item No. to be filled in by customer

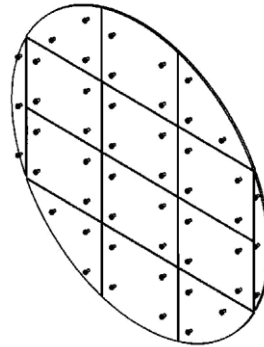

Pos nr. Pos No.	Vare Item	Tekst Description	Antal Qty.	Vare nr. Item No.	Pris/stk. Price/pcs. (EURO)
1		Bundslidplade Hardox 400 Wearing btm Hardox 400	1		
1		Bundslidplade Hardox 600 Wearing btm Hardox 600	1		
1		Bundslidplade Nihard Wearing btm Nihard	1		
2		Aquamatelektrode Aquamatsensor	2	553046	